

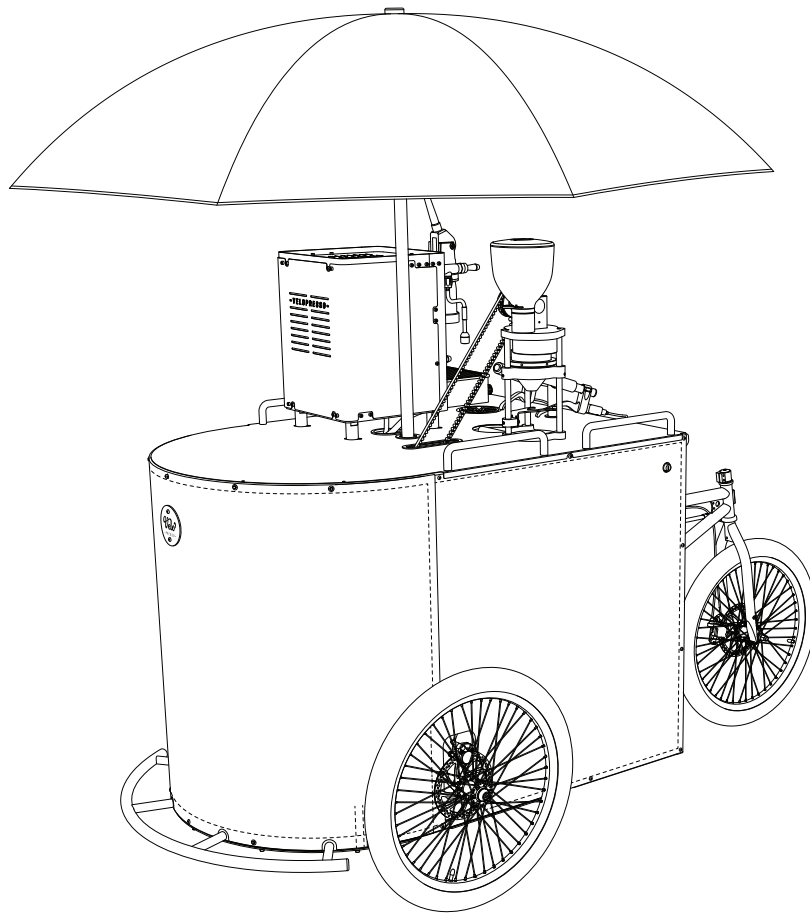

VELOPRESSO COFFEE SERVICE HIRE



ABOUT VELOPRESSO COFFEE TRIKES

Velopresso, the pedal-powered coffee trike, is an award-winning product that is completely unique in the world of artisan coffee and mobile catering. The Velopresso is designed and manufactured in the UK by us, and features the first and only pedal-powered commercial standard coffee grinder in the world among its many innovations.

Velopresso has won awards for the quality of its design, innovation and manufacture. It is also the only truly mobile commercial espresso trike in the world. There are now 24 of our trikes operating in 12 different countries around the [globe](#). We are very proud of the design and UK manufacturing side of our company, were early members of the Made in Britain campaign organisation and were recently voted into the top 100 list of influential businesses in UK manufacturing by *The Manufacturer* magazine.

You can now hire the services of these beautifully engineered and sustainable coffee trikes, complete with professional barista to provide exquisite coffee for your event, while supporting British innovation and manufacture at the same time.

Velopresso Ltd
contact@velopresso.cc
velopresso.cc

Registered in England
Company 08324134
VAT 159 777 545
EORI GB159777545000

Studio 1
6-10 Central Parade
137 Hoe Street
London E17 4RT

COFFEE SERVICE HIRE

Our Coffee Service is a complete package and includes a trained barista, all consumables and a range of branding and menu options. The Velopresso is fully mobile and completely self-sufficient with its' onboard water supply, waste collection and gas powered espresso machine. When indoors or where use of gas is prohibited the espresso machine can be powered by mains electricity. Since 2012 we have provided coffee services for corporate hires, exhibitions and events in London and beyond. We have operated our trikes for clients ranging from the Mayor of London and the Tour de France, to local arts festivals and in iconic London locations both indoors and out, including Trafalgar Square, Covent Garden, and the South Bank. We were also selected by architect Richard Rogers for a 3-month residency as the featured coffee provider in his 2013 retrospective at the Royal Academy of Arts.

Selected Clients:

Birchbox
Bloomberg L.P.
Brooks England
Capital & Counties Properties plc
City of London Corporation
Energy UK
Mayor of London
Rogers, Stirk, Harbour & Partners
Rollapaluza
Royal Academy of Arts
Royal Borough of Kensington & Chelsea
Southbank Centre
Tour de France official Fan Park
London Borough of Waltham Forest
White Arkitekter

MENU

We pedal-grind on demand using a double shot (18g) of Perky Blenders' signature Forest Blend beans. This combination of Colombian (Alto Del Obispo) and Brazilian (Sao Paulo) beans brings rich cocoa, lively orange notes and a smooth hazelnut finish. Drinks are served in takeaway paper cups – either 4oz or 6oz. Organic whole milk is used with Oatly Barista as the non-dairy option. Our standard coffee menu is:

Espresso	Flat White
Macchiato	Cappuccino
Piccolo	Americano

Menu Options:

Please contact us to discuss any of the following options, or other specific requirements you may have for your event:

Iced coffee
Affogato
Brownies, cakes, or pastries
Ceramic cups (these may be an option for small private events)

EQUIPMENT

Velopresso coffee trike (white frame)

Velopresso coffee cart (white frame)

Grinder: GR1-Velo pedal-powered grinder

Coffee Machine: FCL1-Velo, lever machine (single group, gas or electric)

HIRE FEES

All pricing is subject to VAT at 20%

Coffee Service:

The Velopresso coffee service fees are fully inclusive of the trained barista and all consumables, and with one barista we produce 40 - 50 double shot on demand drinks per hour from our single group machine. Output can be increased by hiring an assistant barista or tailoring the menu to your event – please enquire for further details. Please note we normally would need to arrive on site at least 1 hour prior to starting the service.

0–2 hours	£435
then each additional hour	£95 / hour
e.g. 4 hour service =	£625
8 hour service =	£1005

Transit:

We aim to minimise our (and your) carbon-footprint wherever possible and for events up to 8 miles away – where logistics allow – we will ride the Velopresso trike to and from your event. The transit fee is calculated on the distance of the event from our base (London, E17 4RT) as a return trip, but the first 3 miles each way is free. For longer distances or routes unsuitable for cycling the Velopresso trike we transport it by van. The Velopresso *cart* always requires a van for transport. Congestion charge and parking fees as required will be charged on at cost.

0 – 3 miles (cycled)	FREE
3 – 8 miles (cycled)	£7 / mile*
8 – 50 miles** (van)	£95 (van) + £1.50 /mile*

* charged from 3rd mile onwards each way

** for events over 50 miles from our base please

contact us for a transit fee quote

Branding options:

Our default branding for the trike is the black and white 'Perky Blenders x Velopresso' collaboration branding. If you or your client wish to re-brand then full custom panel sets offering 3 square metres of branding space can be made for your event. The trike umbrella supplied is either plain white or a Velopresso / Perky Blenders branded design, but a plain colour or full custom branded umbrella can also be made on request. Other branding options include custom printed cups, or alternatively stickers that can be applied to our standard plain

cups. Please note pricing and lead-times required from receipt of final artwork for these branding options. We can supply graphic design services at £35 p/h if required for preparing your branded items.

Custom Branding Panels, digital print (2 week lead-time)	£320
Umbrella, plain colour canopy (2 week lead-time)	£275
see Specification for the the 17 colours available	
Umbrella, digitally printed canopy (4 week lead-time)	£425
Printed cups (7oz) + lids, x 1000* (3 week lead-time)	£245
Printed cups (4oz) + lids, x 1000* (3 week lead-time)	£245
Cup Stickers, ø35mm, x 500* (1 week lead-time)	£95

* minimum order quantity applies, pricing for larger quantities available on request

Payment:

When a coffee service hire is confirmed we will issue our invoice. All hires require payment in full at least 1 week prior to the event and/or in accord with the terms on the invoice – and is non-refundable. If branding is required then payment in full for the branding and event is required in advance of the branding order being placed with our suppliers. Payment is by bank transfer (BACS) only. Once paid for, the branded items become your property and can be returned to you after the event on request, or we can retain and preserve them for your use at a future event where you require a Velopresso.

ACCESS, DIMENSIONS, CERTIFICATION AND PERMISSIONS, ETC.

If you are interested in hiring, please read the following additional notes below and contact us to discuss the details of your event at the earliest opportunity.

Velopresso Ltd is registered in England and has been trading since 2013. We have public liability insurance cover, and our specially trained baristas will have a minimum of a Level 2 Food Hygiene certificate. We are members of NCASS (Nationwide Caterers Association) and follow their well established Due Dilligence System. Our Velopressos are certified for use as mobile catering vehicles and have 6-monthly checks by Gas-Safe registered engineers.

A Velopresso can be used both outside and indoors and have been operated in many landmark locations and buildings including the Royal Academy of Arts. The espresso machine is heated by mains electricity when used indoors or with bottled gas (propane) when outside. In some circumstances it may be preferable to run the espresso machine on gas (butane) when indoors, and this may be permissable pending approval by the landlord.

The full dimensions of the Velopresso (both trike and cart options) are provided below. Prior to confirming our availability for your event we will need to be certain that it is possible for the Velopresso to access the location. It is not normally possible to lift the Velopresso but ramps can be used to bridge steps of up to 0.5m high. Please discuss access with us prior to booking.

Please don't hesitate to phone or email us with questions.

contact@velopresso.cc +44 (0)7939 014 891

TRIKE DIMENSIONS

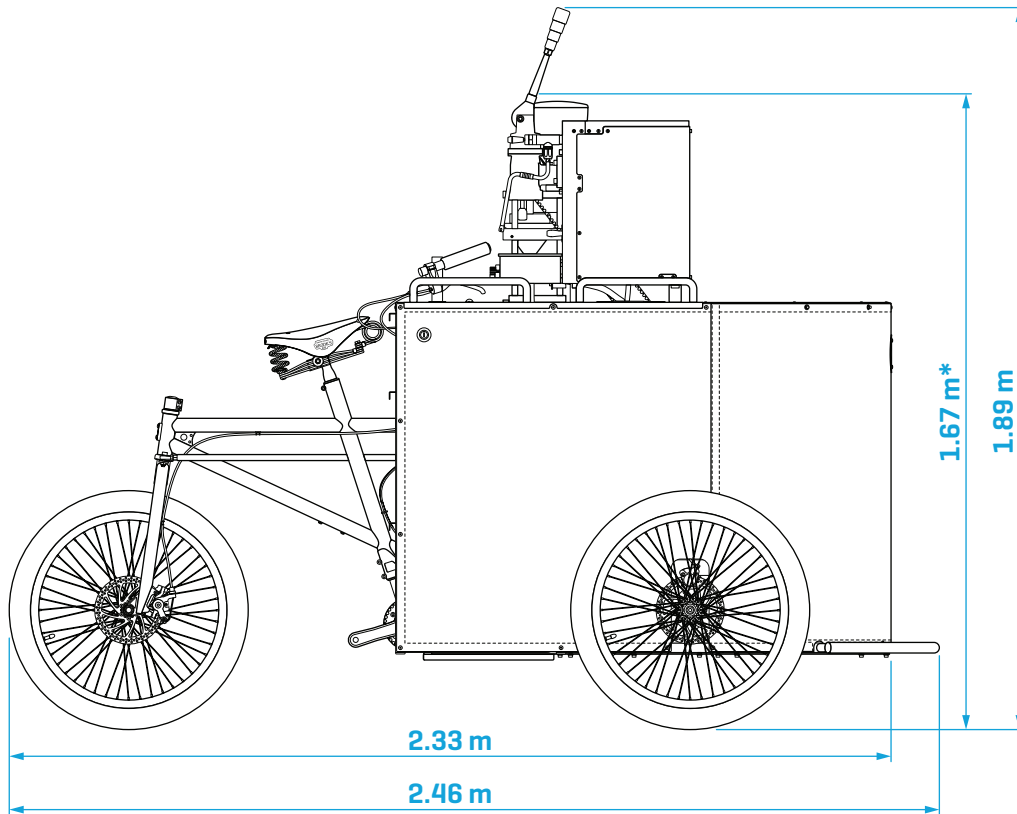

*height with the espresso machine lever removed

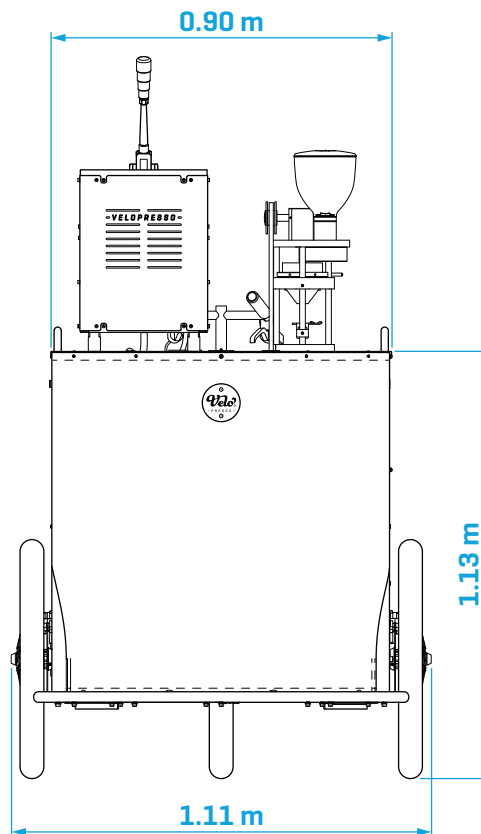

CART DIMENSIONS

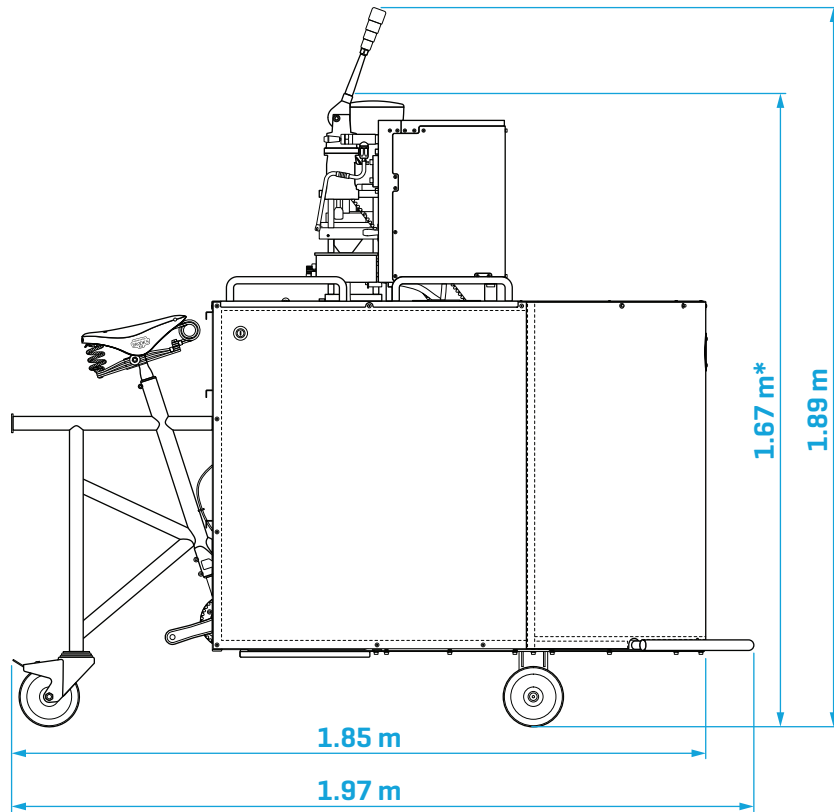

*height with the espresso machine lever removed

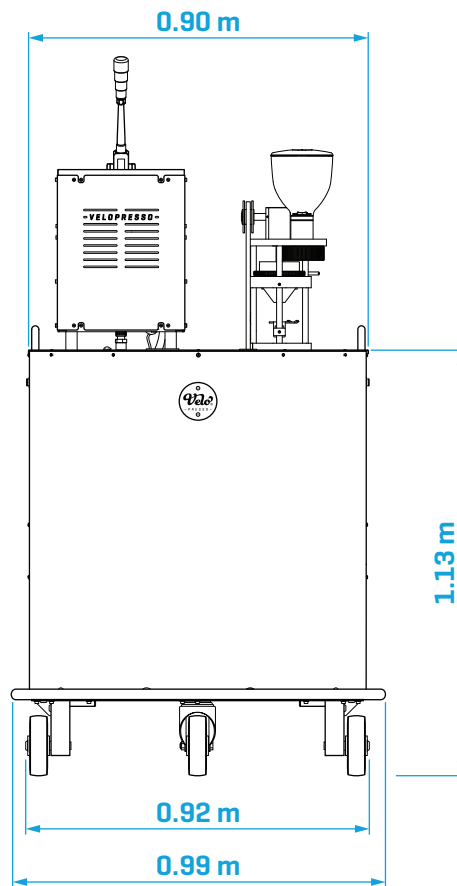

UMBRELLA DIMENSIONS

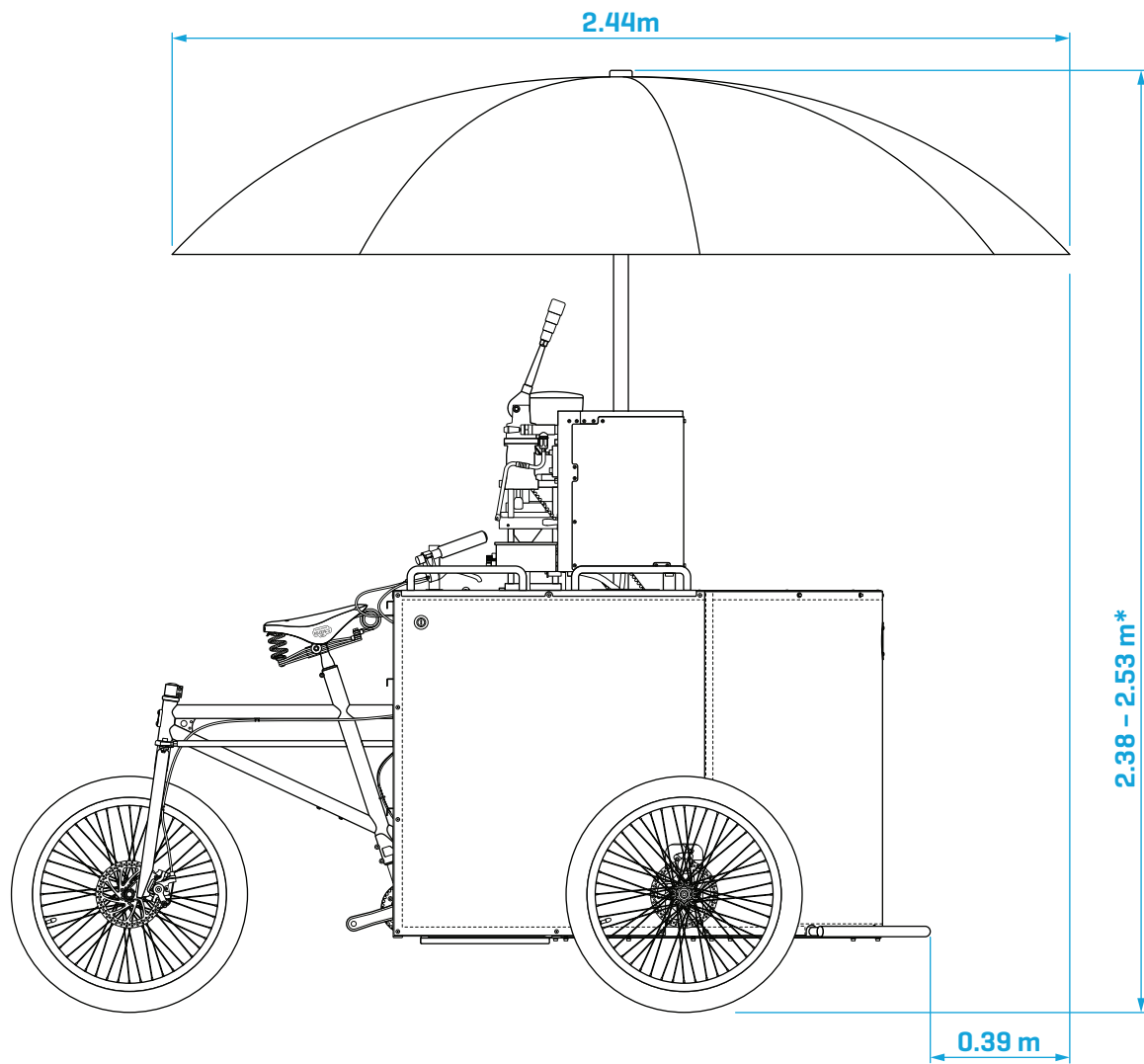

***height adjustable within the given approximate range**